

Model
BPN-3

Bocchello getto pieno/nebulizzato

Full jet / Fog nozzle



Getto pieno
Full jet

Massima apertura - Getto nebulizzato
Maximum opening - Fog jet

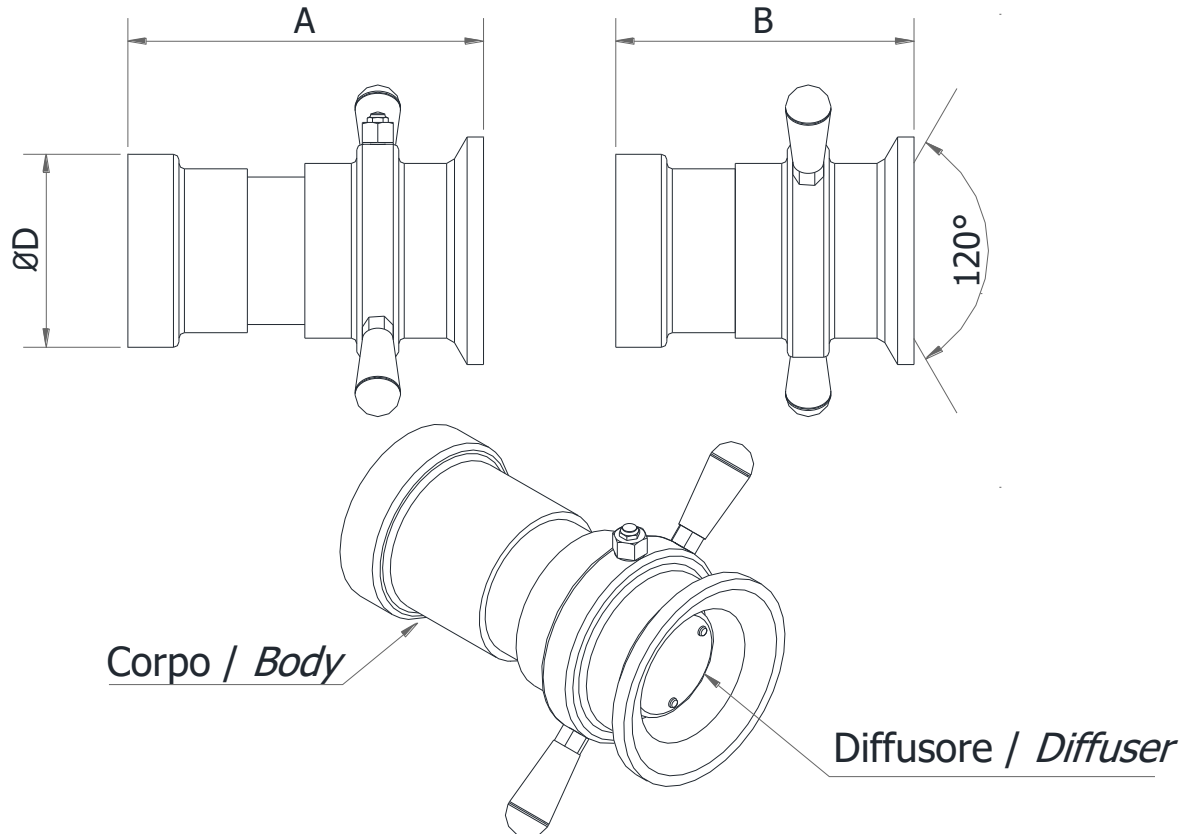

Modello <i>Model</i>	Portata a 7 bar <i>flow rate at 7 bar</i> l/min	ØD GAS-BSP F	A	B	Peso/Weight,kg
					AL*
BPN-3-30	3000	3", 4"	200	170	5.4
BPN-3-40	4000	3", 4"	200	170	5.4
BPN-3-50	5000	3", 4"	200	170	5.4

* AL: lega leggera anodizzata (*light anodized alloy*)

Specifiche – Specifications

Corpo: lega leggera anodizzata	<i>Body: light anodized alloy</i>
Diffusore : bronzo	<i>Diffuser : bronze</i>
Finitura: Naturale	<i>Finish : Natural</i>

A richiesta – Optional

Portate diverse su richiesta	<i>Different flow rates on request</i>
------------------------------	--

Certificazioni - Certifications



Model

BPN-3

Bocchello getto pieno/nebulizzato

Full jet / Fog nozzle

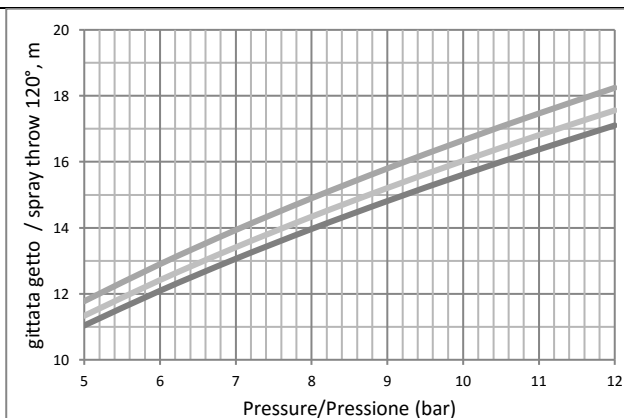
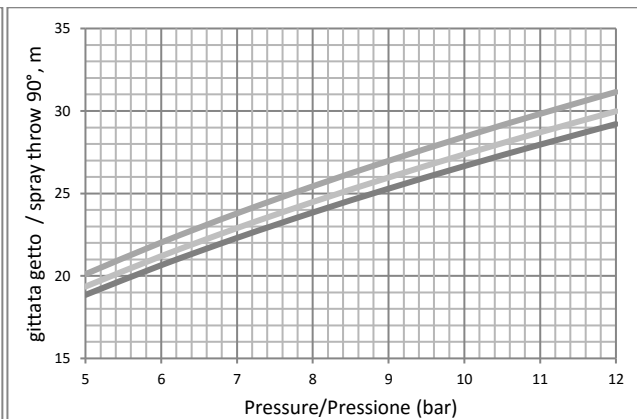
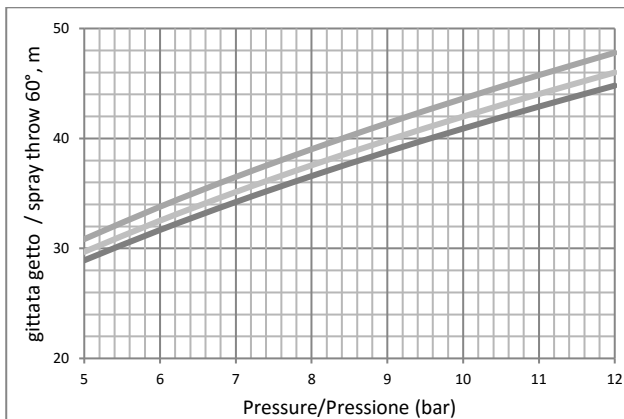
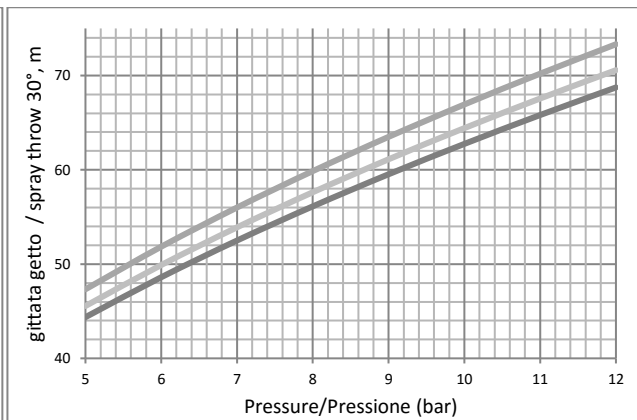
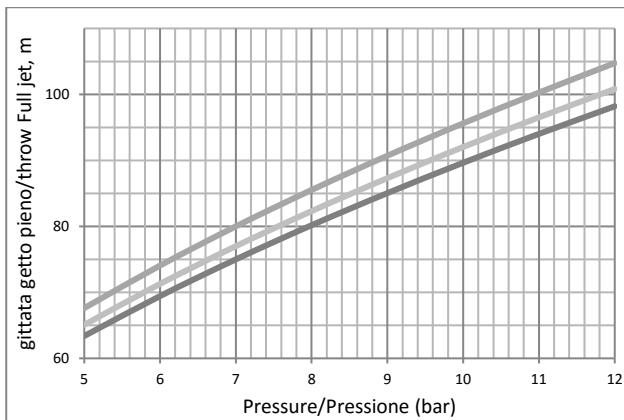
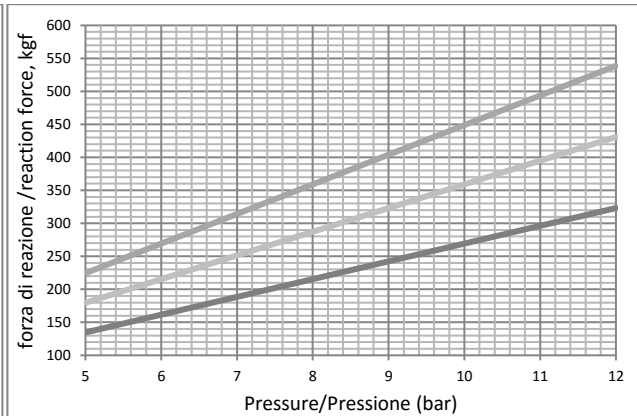
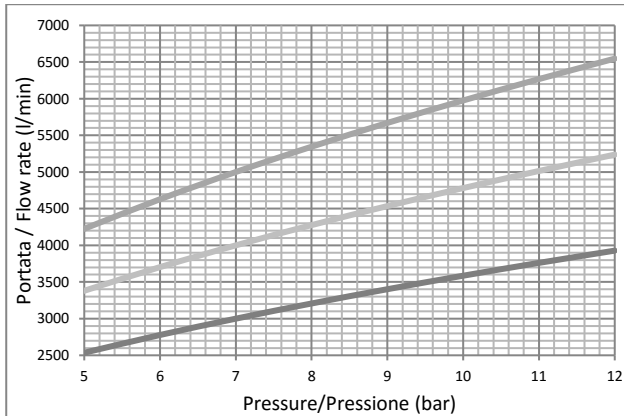

Ordine di lettura dei grafici
Graphics reading order



BPN-3-50
BPN-3-40
BPN-3-30

Vedi sezione 4-2-0 per ulteriori informazioni / See section 4-2-0 for additional information