

Model
BPN-6

Bocchello getto pieno/nebulizzato

Full jet / Fog nozzle

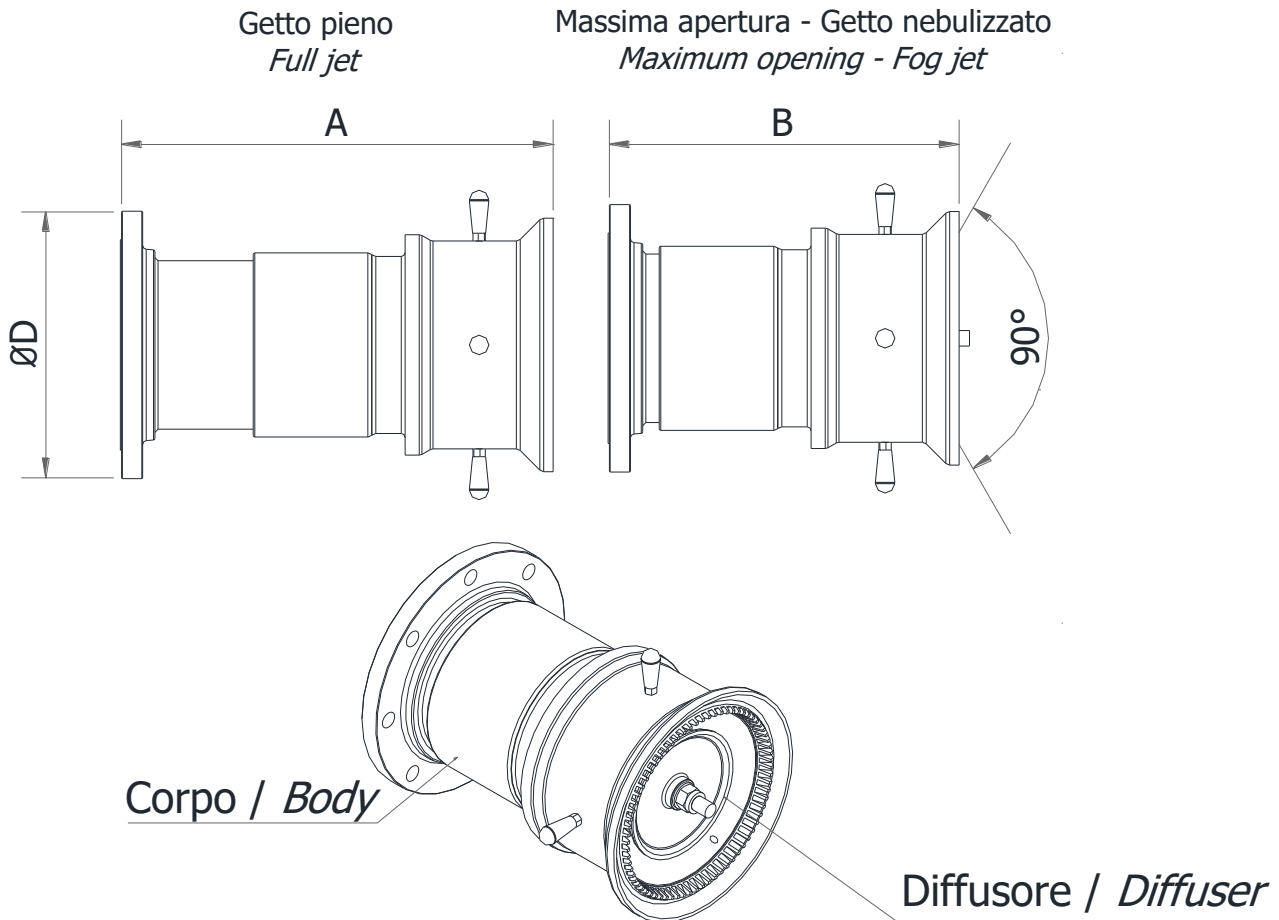

Modello Model	Portata a 7 bar flow rate at 7 bar l/min	ØD ISO PN16 ANSI #150	A	B	Peso, kg Weight, kg
BPN-6-200	20000	8"	550	450	80
BPN-6-230	23000	8"	550	450	80

Specifiche – Specifications

Corpo: acciaio inox AISI 304(*) / Bronzo	Body: stainless steel AISI 304(*) / Bronze
Diffusore : bronzo	Diffuser : bronze
Finitura: Naturale	Finish : Natural

A richiesta – Optional

Portate diverse su richiesta	Different flow rates on request
(*) acciaio inox AISI 316	(*) Stainless steel AISI 316

Certificazioni - Certifications



Model
BPN-6

Bocchello getto pieno/nebulizzato

Full jet / Fog nozzle

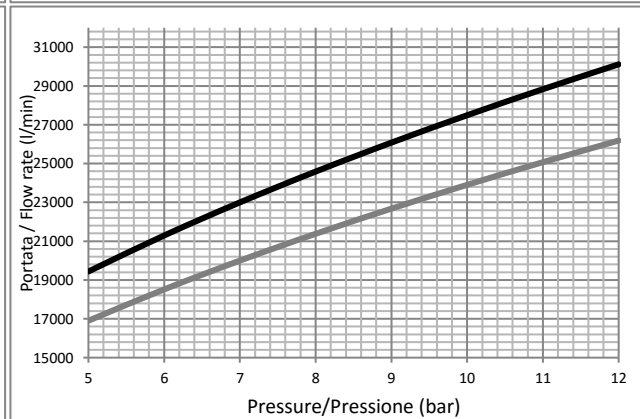
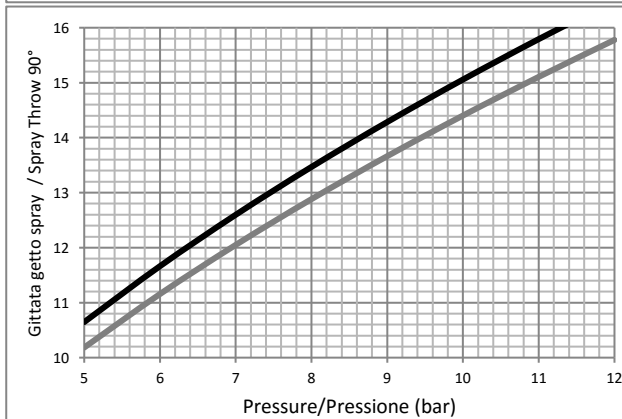
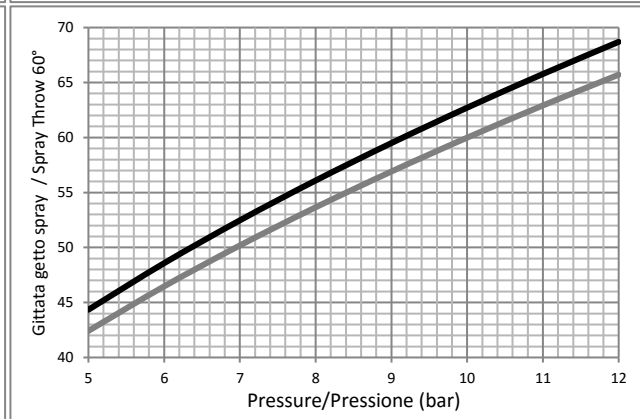
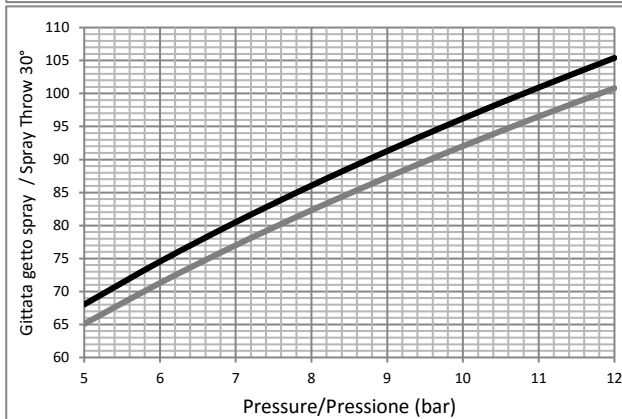
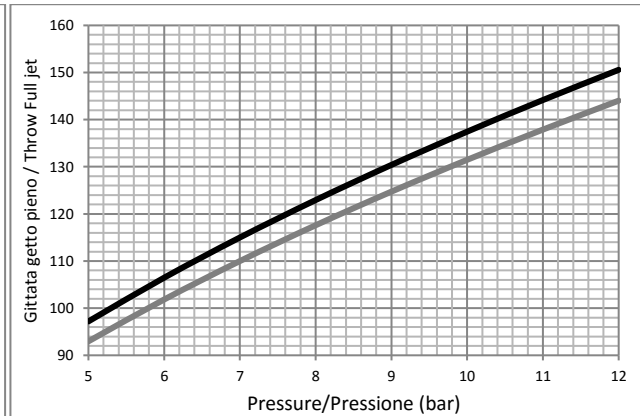
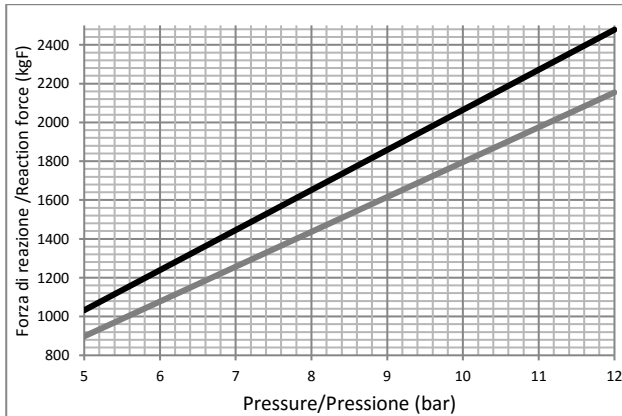

Ordine di lettura dei grafici
Graphics reading order

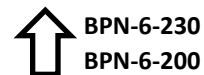

BPN-6-230
BPN-6-200

Vedi sezione 4-2-0 per ulteriori informazioni / See section 4-2-0 for additional information