

Bocchello getto pieno/nebulizzato autospirante

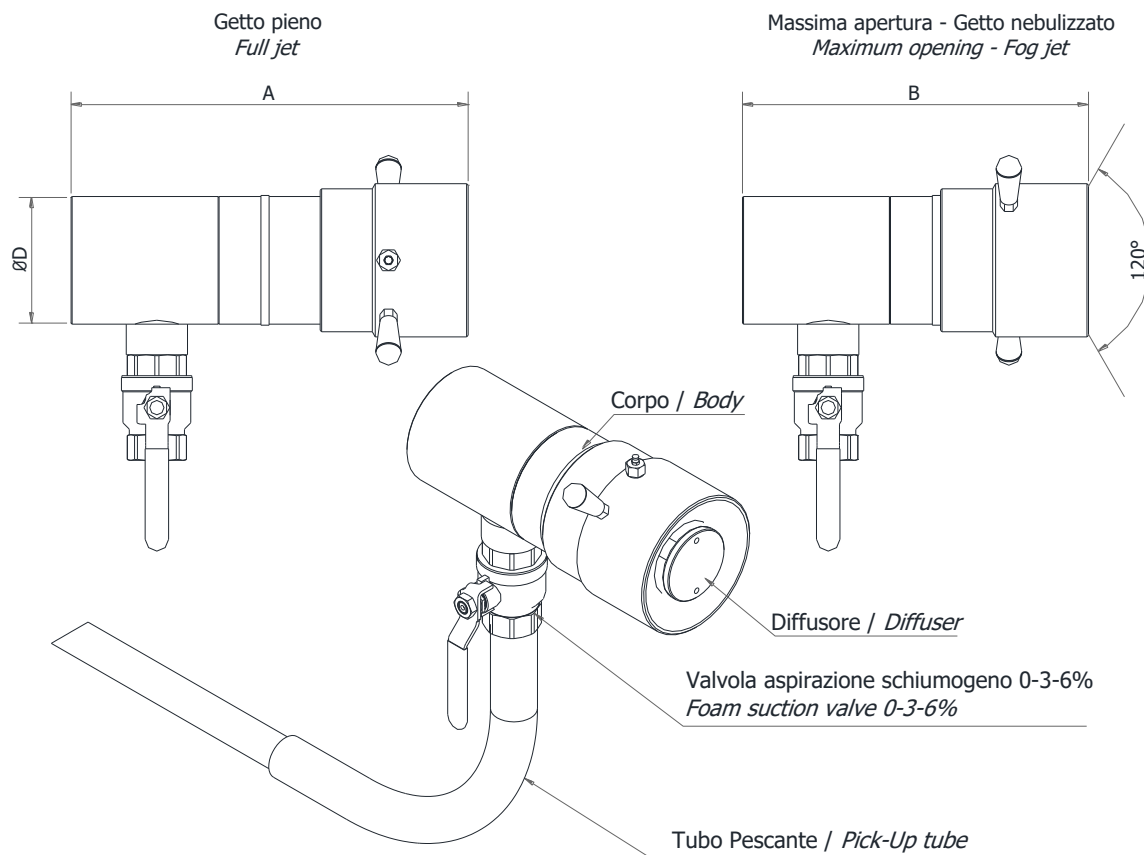

Model
BPN-A-4

Self aspirating full jet / fog nozzle



Modello Model	Portata a 7 bar flow rate at 7 bar l/min	ØD GAS-BSP F	A	B	Peso, kg Weight, kg
BPN-A-4-40	4000	3"-4"	425	375	12
BPN-A-4-50	5000	4"	425	375	12
BPN-A-4-60	6000	4"	425	375	12
BPN-A-4-70	7000	4"	425	375	12

Specifiche – Specifications

Corpo: acciaio inox AISI 304	Body: stainless steel AISI 304
Diffusore: bronzo	Diffuser: bronze
Valvola aspirazione schiumogeno (0-3-6%)	Foam suction valve (0-3-6%)
Corpo e sfera: acciaio inox	body and sphere: stainless steel
Tubo pescante: PVC con spirale d'acciaio interna	Pick-up tube: PVC with internal spiral steel reinforcement
Finitura: naturale	Finish: Natural

A richiesta – Optional

Corpo: acciaio inox AISI 316	Body: stainless steel AISI 316
Portate diversa su richiesta	Different flow rates

Certificazioni - Certifications



Bocchello getto pieno/nebulizzato autospirante

Model

BPN-A-4

Self aspirating full jet / fog nozzle

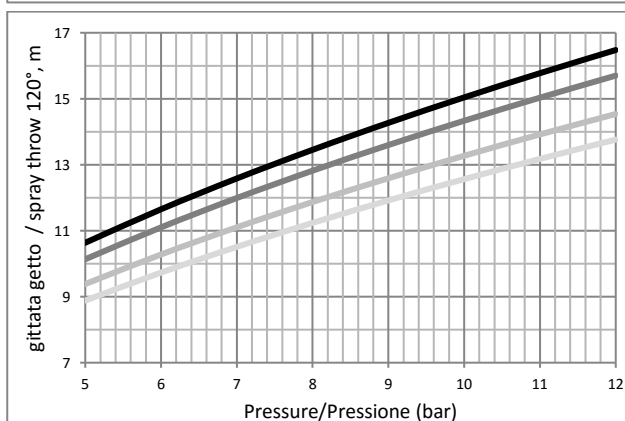
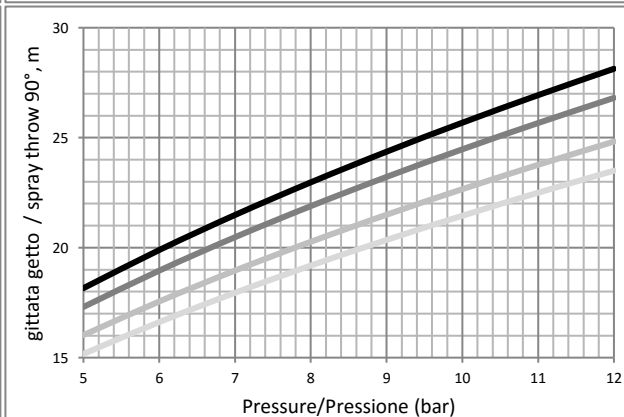
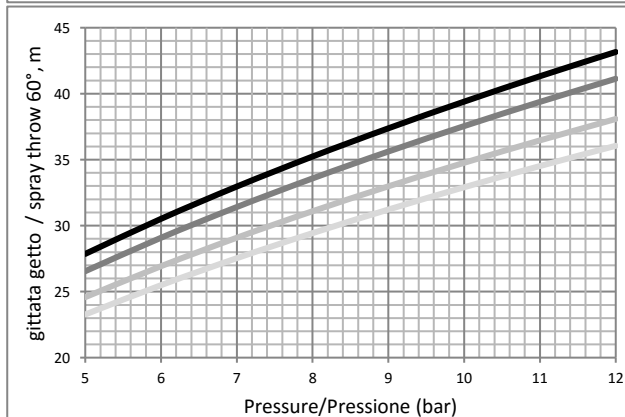
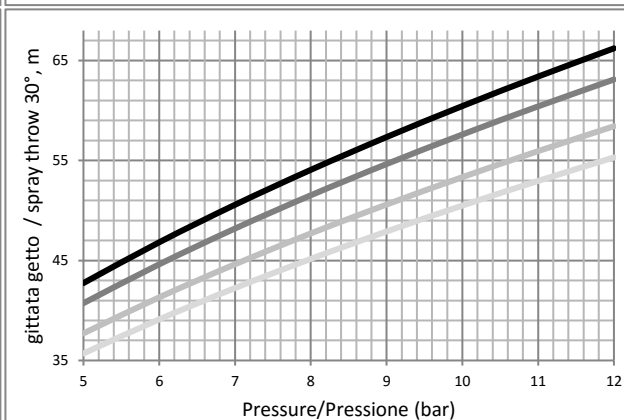
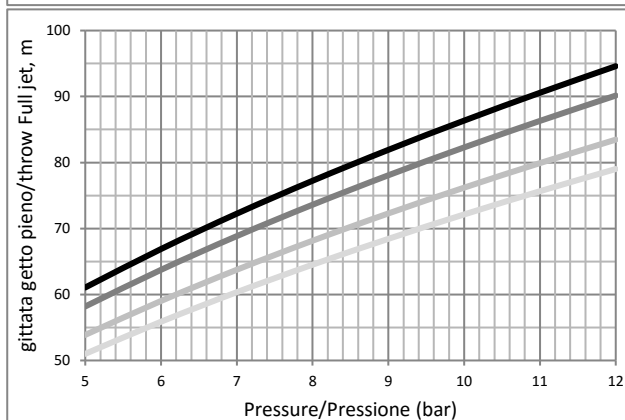
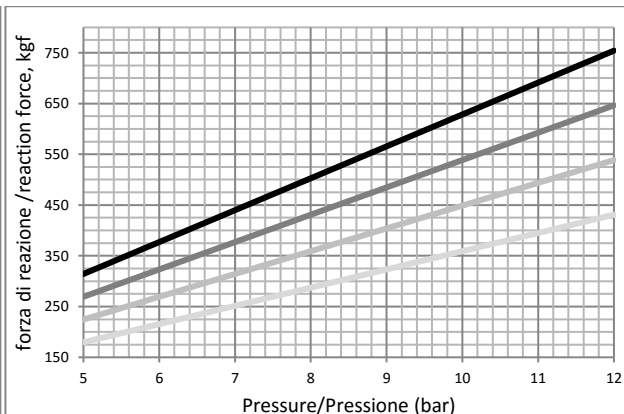
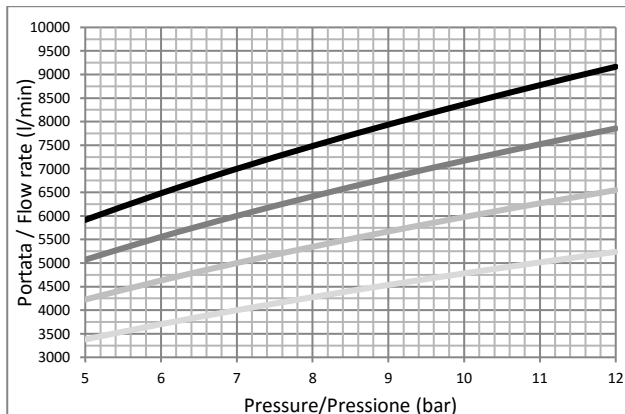

**Ordine di lettura dei grafici
Graphics reading order**



**BPN-4-70
BPN-4-60
BPN-4-50
BPN-4-40**

Vedi sezione 4-2-0 per ulteriori informazioni / See section 4-2-0 for additional information