

Bocchello getto pieno/nebulizzato autospirante

Model

BPN-A5

Self aspirating full jet / fog nozzle

FOR REFERENCE ONLY

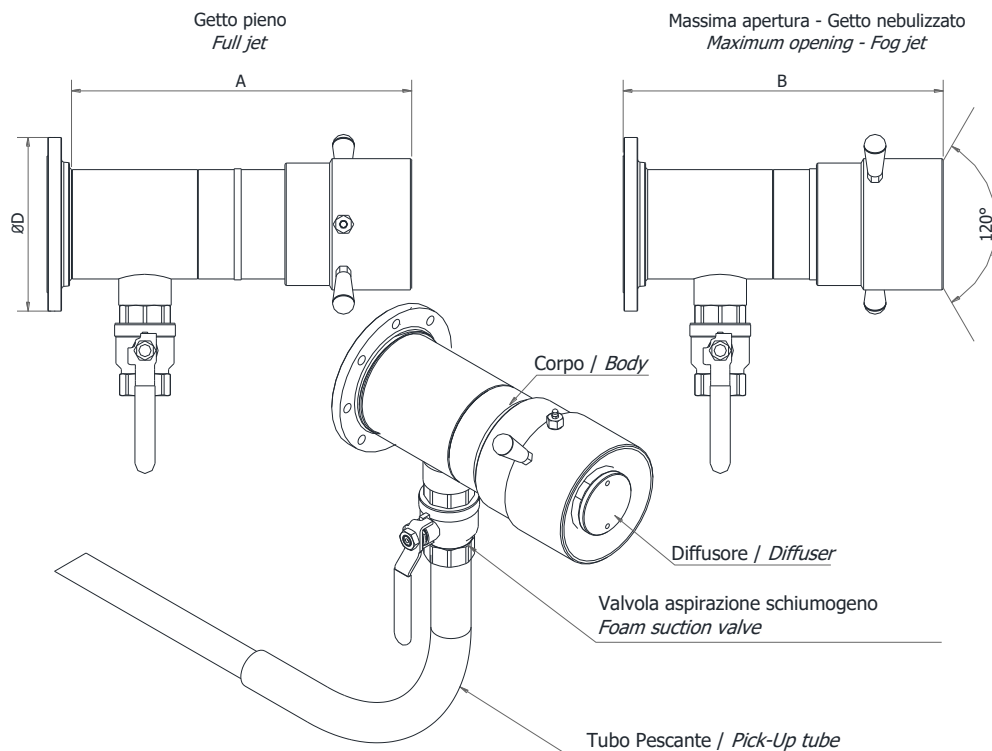

Modello Model	Portata a 7 bar flow rate at 7 bar l/min	ØD ISO PN 16 ANSI#150	A	B	Peso, kg Weight, kg
BPN-A5-100	10000	5"-6"	590	540	28
BPN-A5-120	12000	5"-6"	590	540	28

Specifiche – Specifications

Corpo: acciaio inox AISI 304	Body: stainless steel AISI 304
Diffusore : bronzo	Diffuser: bronze
Valvola aspirazione schiumogeno (0-1-3%)	Foam suction valve (0-1-3%)
Corpo e sfera: acciaio inox	body and sphere: stainless steel
Tubo pescante: PVC con spirale d'acciaio interna altezza max. aspirazione 1.5 mt lunghezza max: 2.25 mt	Pick-up tube: PVC with internal spiral steel reinforcement max. suction height: 1.5 mt max. hose length: 2.25 mt
Finitura: Naturale	Finish : Natural
Max lung. tubo pescante: 2.25 m	Max

A richiesta – Optional

Corpo: acciaio inox AISI 316	Body: stainless steel AISI 316
Portate diversa su richiesta	Different flow rates

Certificazioni - Certifications



Bocchello getto pieno/nebulizzato autospirante



Model

BPN-A5

Self aspirating full jet / fog nozzle

FOR REFERENCE ONLY

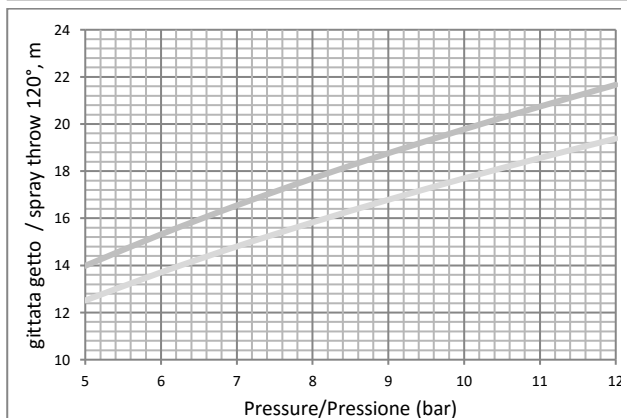
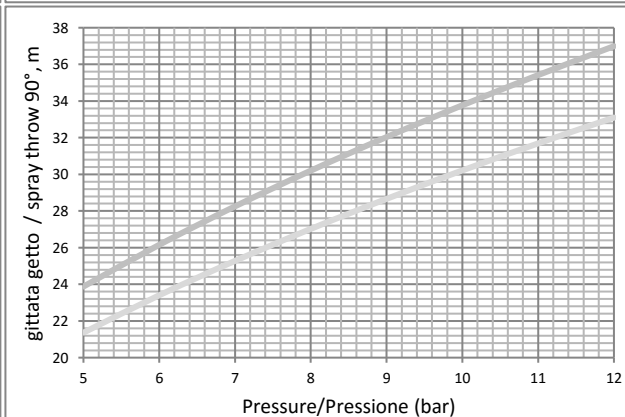
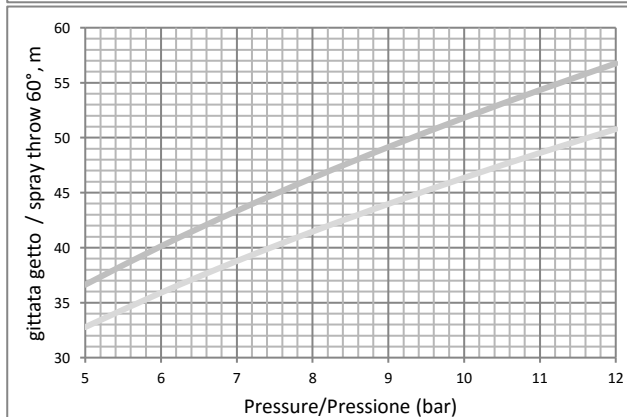
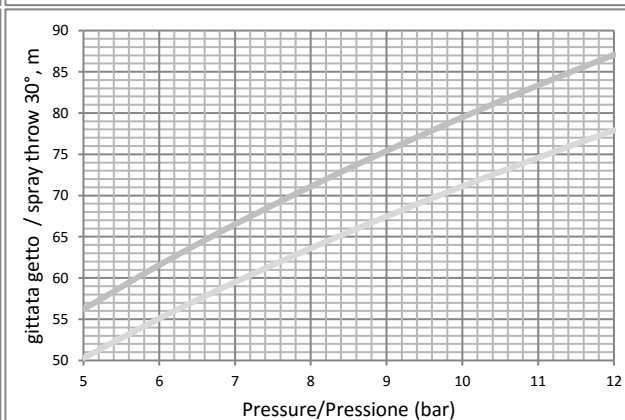
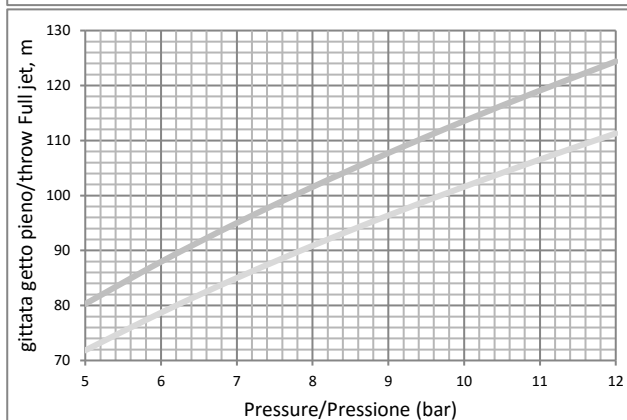
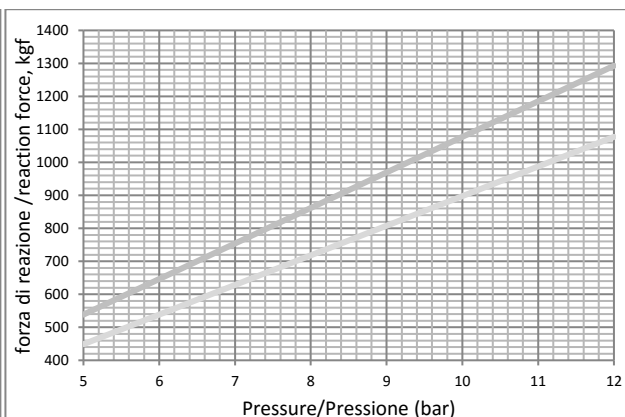
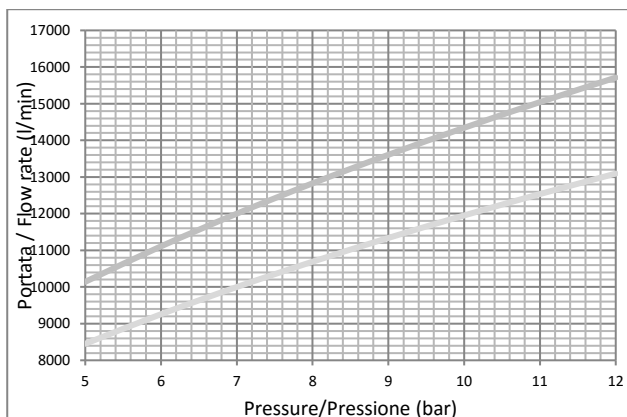

Ordine di lettura dei grafici
Graphics reading order

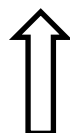

BPN-A5-100

BPN-A5-120

Vedi sezione 4-2-0 per ulteriori informazioni / See section 4-2-0 for additional information