

Bocchello elettrico getto

pieno/nebulizzato

Electric operated full jet / fog nozzle

Model

BPN-E5

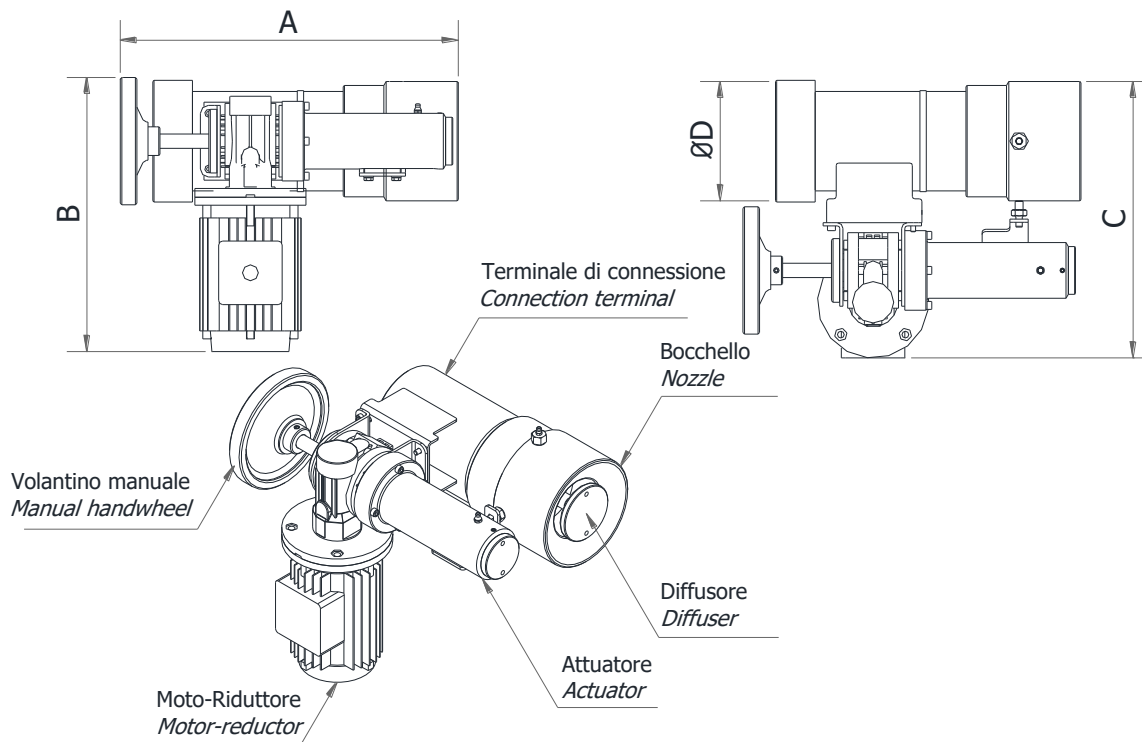

| Modello Model | Portata a 7 bar flow rate at 7 bar l/min | ØD GAS-BSP F | A | B | C | Peso, kg Weight, kg |
|------------------|--|-----------------|-----|-----|-----|------------------------|
| BPN-E5-70 | 7000 | 5", 6" | 430 | 345 | 350 | 28 |
| BPN-E5-80 | 8000 | 5", 6" | 430 | 345 | 350 | 28 |
| BPN-E5-90 | 9000 | 5", 6" | 430 | 345 | 350 | 28 |
| BPN-E5-100 | 10000 | 5", 6" | 430 | 345 | 350 | 28 |
| BPN-E5-150 | 15000 | 5", 6" | 430 | 345 | 350 | 28 |

Specifiche – Specifications

| | |
|--|--|
| Terminale di connessione: acciaio inox AISI 304(*) | Connection terminal: Stainless steel AISI 304(*) |
| Bocchello: acciaio inox AISI 304(*)/ bronzo | Nozzle: Stainless Steel AISI 304(*)/bronze |
| Diffusore: bronzo | Diffuser: bronze |
| Attuatore / Moto riduttore : lega leggera | Actuator / Motor-reductor: Light alloy |
| Motore: 230V AC, 1F / 400V AC, 3F; 0,25 kW; IP 66 | Motor: 230V AC, 1ph / 400V AC, 3ph; 0,25 kW; IP 66 |
| Fine corsa meccanico con limitatori di coppia | End switch safety clutch |
| Finitura: ciclo di verniciatura CSI#2 (vedi sezione 0-3-3-2) | Finish: coating cycle CSI#2 (see section 0-3-3-2) |

A richiesta – Optional

| | |
|---|--|
| Motori con i voltaggi diversi | Motors with different voltages |
| Fine corsa elettrica / Potenziometro | Electrical end switch / Potentiometer |
| Attuatori intelligenti AUMA® | AUMA® intelligent actuators |
| Motore elettrico versione ATEX: 0,18 kW | Electrical motor ATEX version: 0,18 kW |
| (*) acciaio inox AISI 316 | (*) Stainless steel AISI 316 |
| Portate diverse su richiesta | Different flow rates on request |

Certificazioni - Certifications



Bocchello elettrico getto

pieno/nebulizzato

Electric operated full jet / fog nozzle



Model

BPN-E5

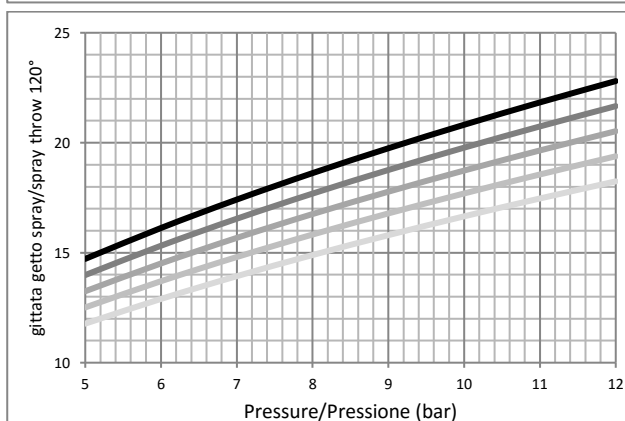
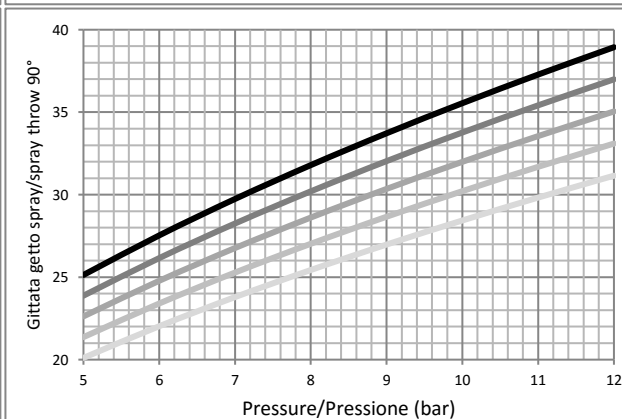
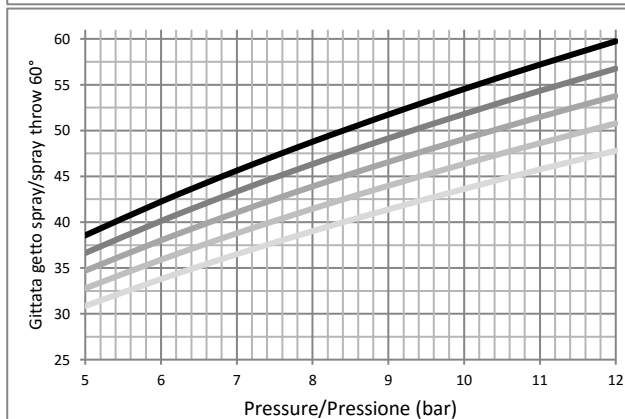
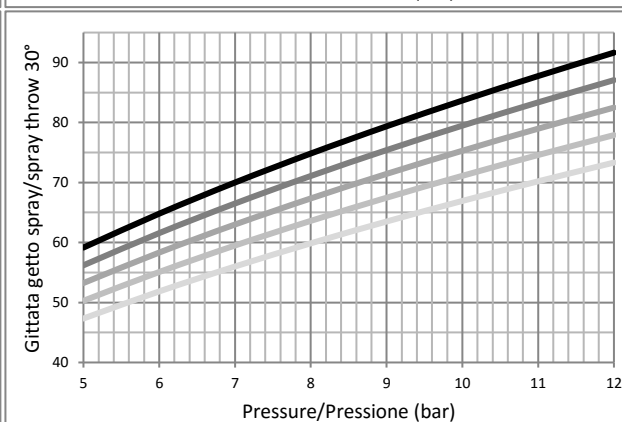
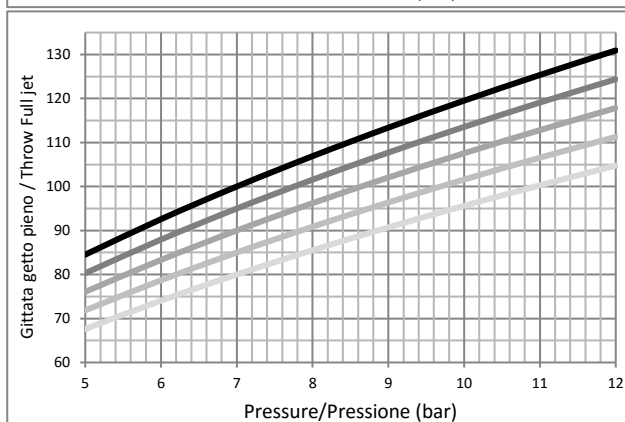
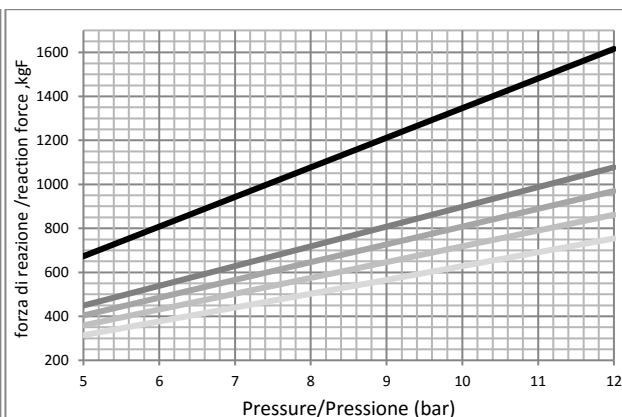
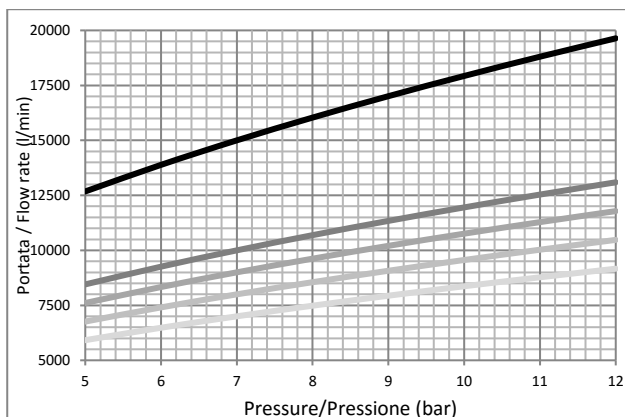

Ordine di lettura dei grafici
Graphics reading order



- BPN-E5-150**
- BPN-E5-100**
- BPN-E5-90**
- BPN-E5-80**
- BPN-E5-70**

Vedi sezione 4-2-0 per ulteriori informazioni / See section 4-2-0 for additional information