

# Bocchello oleodinamico getto

## pieno/nebulizzato

### Hydraulic operated full jet / fog nozzle

Model

**BPN-O1**

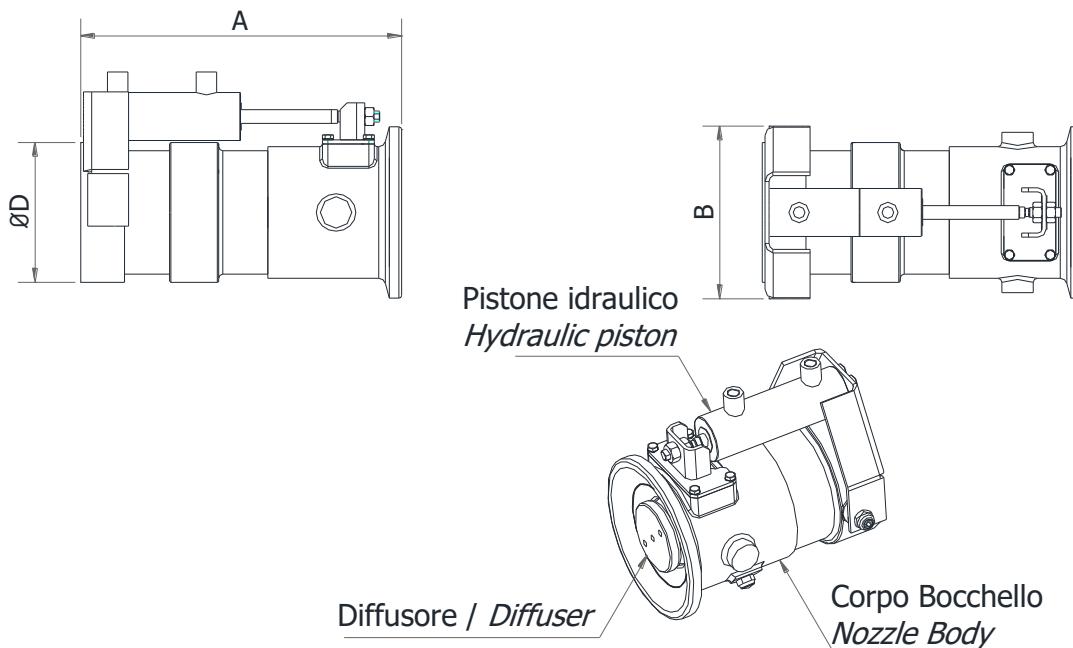

Modello Model	Portata a 7 bar flow rate at 7 bar l/min	ØD GAS-BSP F	A	B	Peso/Weight, kg	
					AL*	BZ*
BPN-O1-5	500	3"	245	126	11	15
BPN-O1-10	1000	3"	245	126	11	15
BPN-O1-15	1500	3"	245	126	11	15
BPN-O1-20	2000	3"	245	126	11	15
BPN-O1-25	2500	3"	245	126	11	15

\* AL: Lega leggera anodizzata (light anodized alloy) / BZ: Bronzo (bronze)

#### Specifiche – Specifications

Corpo bocchello: Lega leggera anodizzata o bronzo	Nozzle body: light anodized alloy or bronze
Diffusore: bronzo	Diffuser: bronze
Pistone idraulico: acciaio inox	Hydraulic piston: stainless steel
Finitura: naturale	Finish: natural
Portata diversa su richiesta	Another flow rate by request
Finitura: ciclo di verniciatura CSI#2 (vedi sezione 0-3-3-2)	Finish: coating cycle CSI#2 (see section 0-3-3-2)

#### A richiesta – Optional

Portate diverse su richiesta	Different flow rates on request
------------------------------	---------------------------------

#### Certificazioni - Certifications



# Bocchello oleodinamico getto

## pieno/nebulizzato

Model

**BPN-O1**

*Hydraulic operated full jet / fog nozzle*

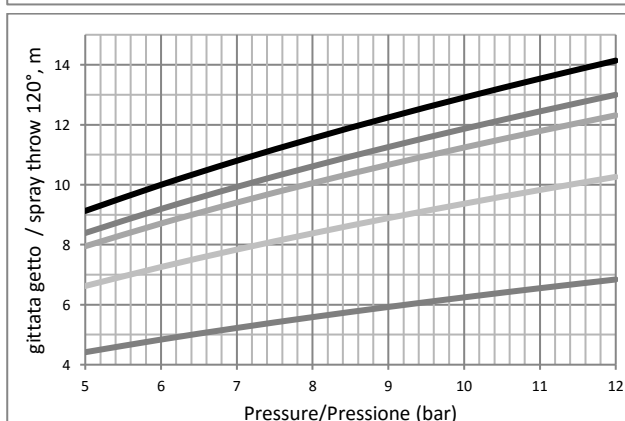
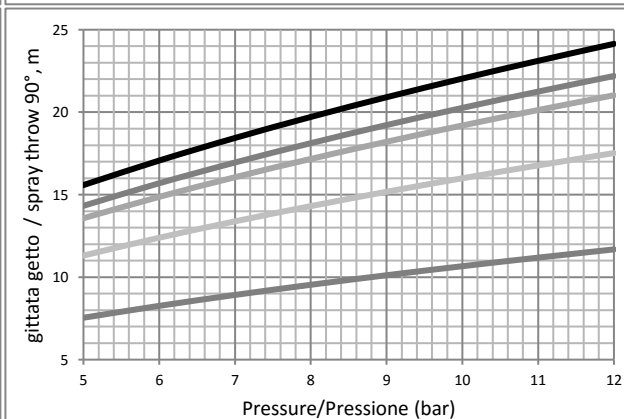
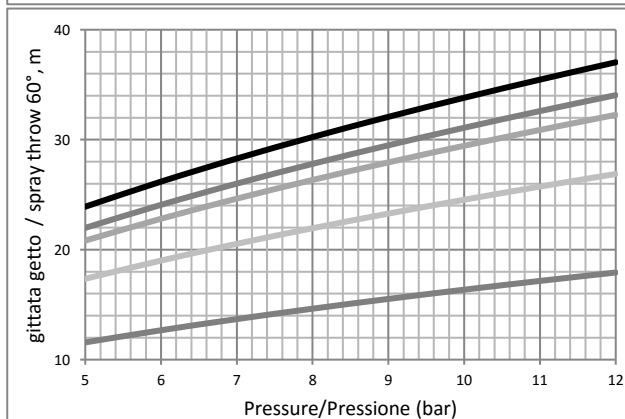
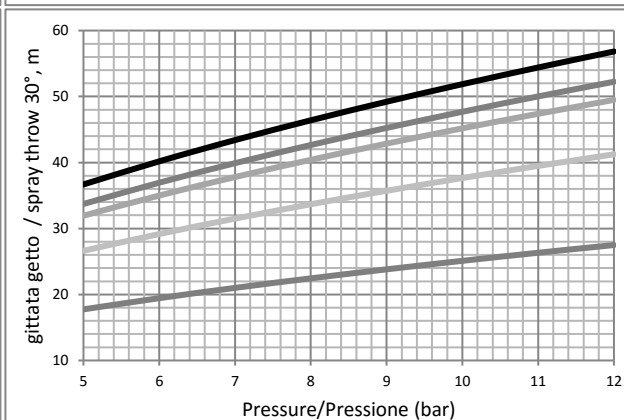
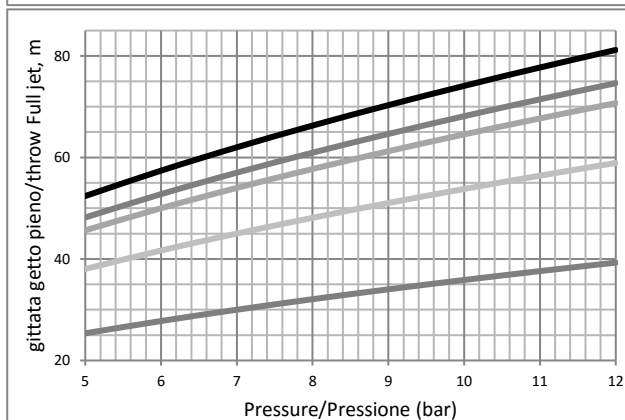
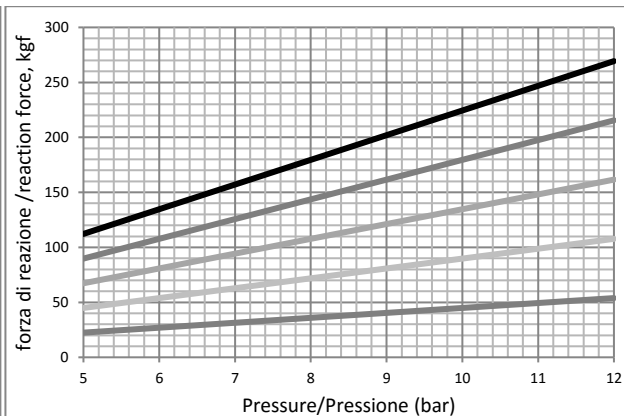
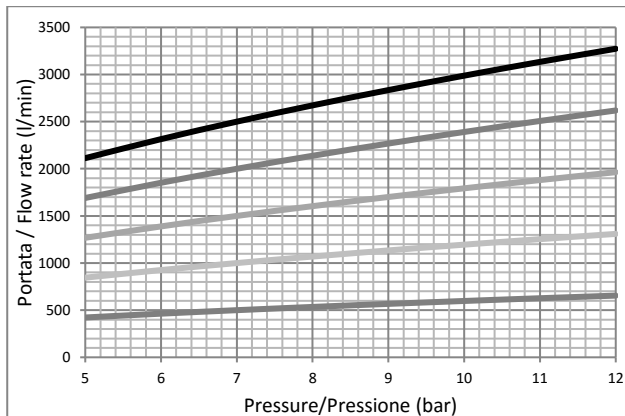

**Ordine di lettura dei grafici**  
*Graphics reading order*

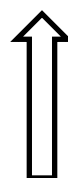

- BPN-O1-25**
- BPN-O1-20**
- BPN-O1-15**
- BPN-O1-10**
- BPN-O1-5**

**Vedi sezione 4-2-0 per ulteriori informazioni / See section 4-2-0 for additional information**