

Bocchello oleodinamico getto

pieno/nebulizzato

Hydraulic operated full jet / fog nozzle

Model

BPN-O4

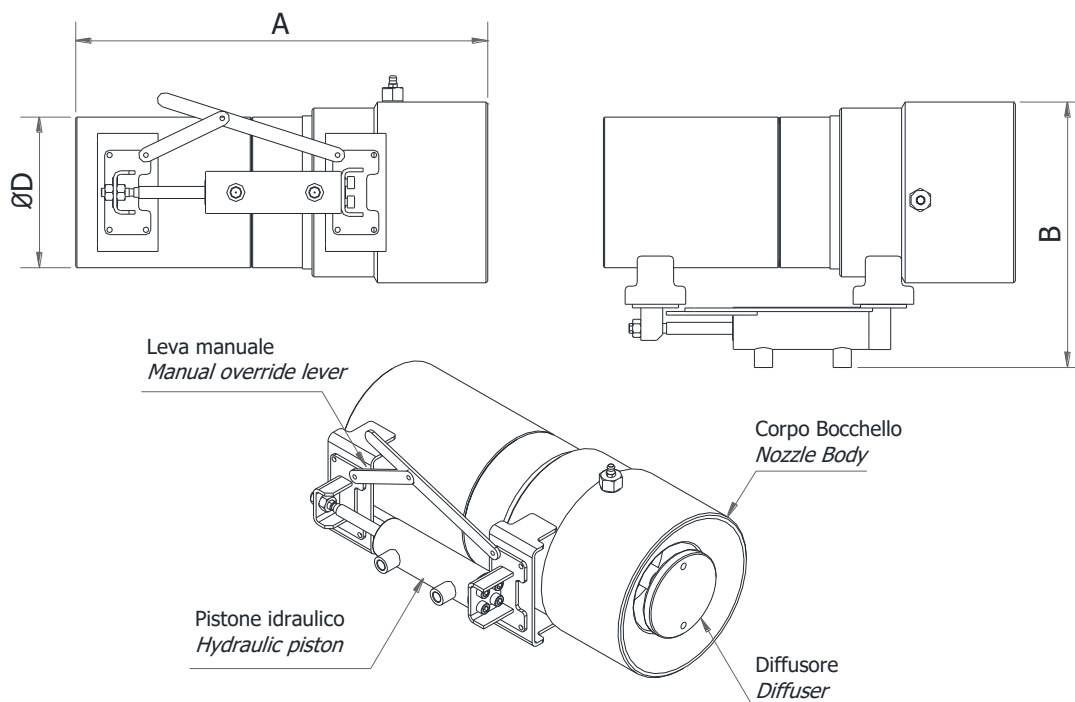

Modello Model	Portata a 7 bar flow rate at 7 bar l/min	ØD GAS-BSP F	A	B	Peso, kg Weight, kg
BPN-O4-40	4000	3"-4"	450	265	19
BPN-O4-50	5000	4"	450	265	19
BPN-O4-60	6000	4"	450	265	19
BPN-O4-70	7000	4"	450	265	19

Specifiche – Specifications

Corpo bocchello: acciaio inox AISI 304	Nozzle body: stainless steel AISI 304
Diffusore : bronzo	Diffuser: bronze
Pistone idraulico: acciaio inox	Hydraulic piston: stainless steel
Finitura: ciclo di verniciatura CSI#2 (vedi sezione 0-3-3-2)	Finish: coating cycle CSI#2 (see section 0-3-3-2)

A richiesta – Optional

Corpo: acciaio inox AISI 316	Body: stainless steel AISI 316
Portate diverse su richiesta	Different flow rates on request
Leva manuale: acciaio inox	Manual override lever: stainless steel

Certificazioni - Certifications



Bocchello oleodinamico getto

pieno/nebulizzato

Model

BPN-O4

Hydraulic operated full jet / fog nozzle

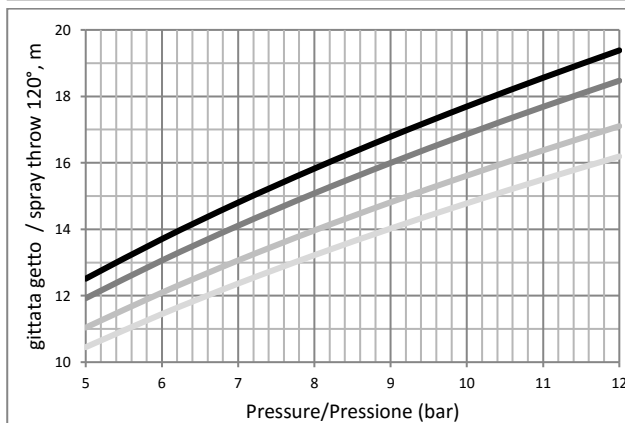
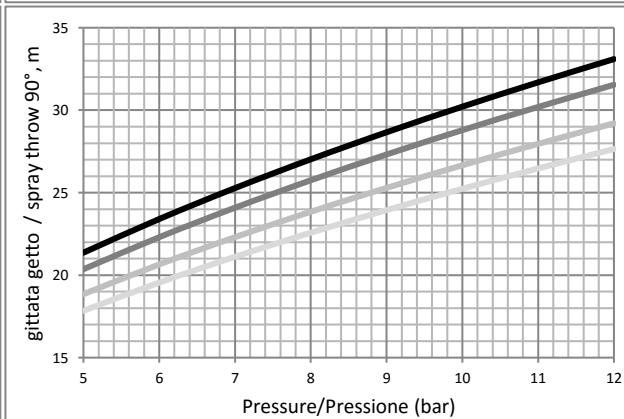
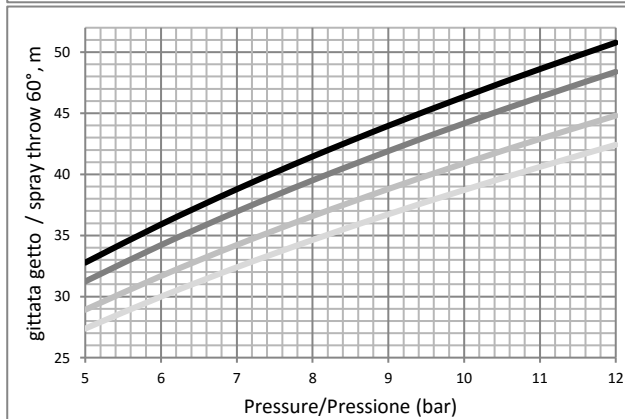
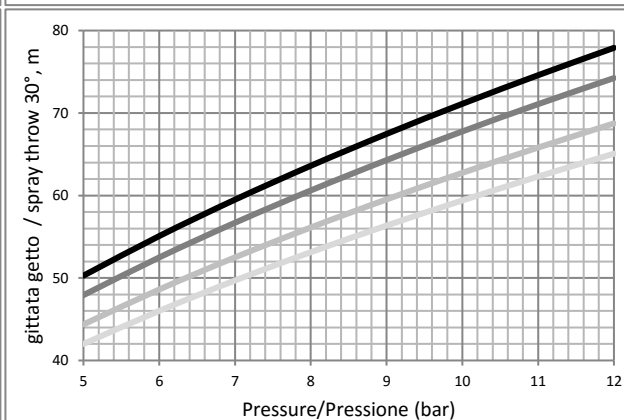
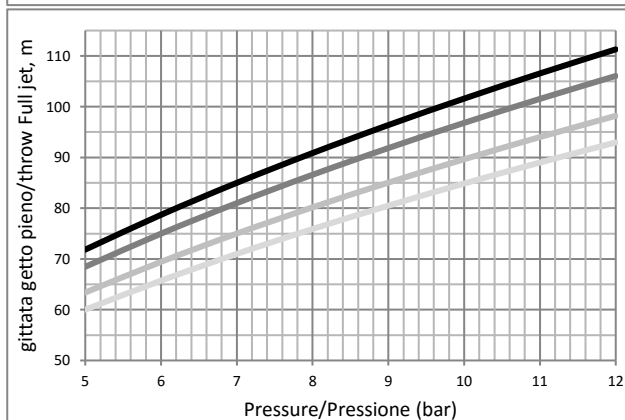
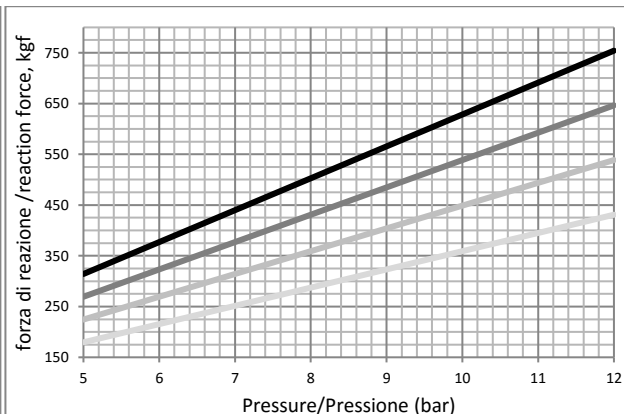
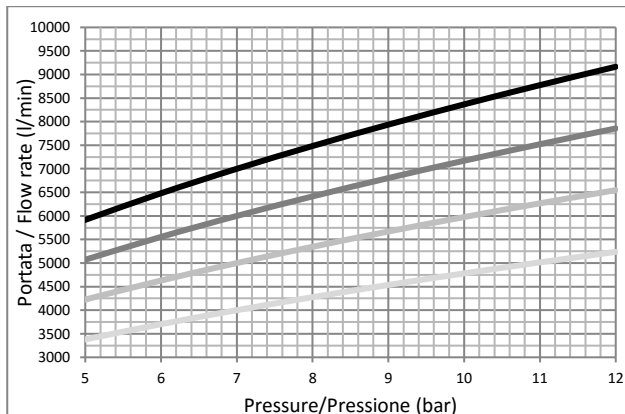

Ordine di lettura dei grafici
Graphics reading order



- BPN-O4-70
- BPN-O4-60
- BPN-O4-50
- BPN-O4-40

Vedi sezione 4-2-0 per ulteriori informazioni / See section 4-2-0 for additional information